

SONY®



Quick Reference

SCPH-90002

SCPH-90003

Before using this product, carefully read the supplied documentation and retain it for future reference.

3-289-799-52(1)

Warning

To reduce the risk of fire or electric shock, do not expose this apparatus to rain or moisture.

To prevent fire or shock hazard, do not place a container filled with liquids on top of the console.

To avoid electrical shock, do not open the cabinet. Refer servicing to qualified personnel only.

Caution

Use of controls or adjustments or performance of procedures other than those specified herein may result in hazardous radiation exposure.

The use of optical instruments with this product will increase eye hazard.

CLASS 1 LASER PRODUCT
LUOKAN 1 LASERLAITE
KLASS 1 LASERAPPARAT

This appliance is classified as a CLASS 1 LASER product under IEC60825-1: 2001.

This equipment has been tested and found to comply with the limits set out in the EMC Directive using a connection cable shorter than 3 metres (9.8 feet).

Place the console at least 10 cm (4 in) away from walls or surrounding objects. Placing the console close to walls or other objects can cause it to overheat.

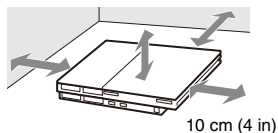

Read carefully before operating your PlayStation®2 console

A few people may experience epileptic seizures when viewing flashing lights or patterns in our daily environment. These persons may experience seizures while watching TV or playing video games, including DVD-Videos or games played on the PlayStation®2 console. Players who have not had any seizures may nonetheless have an undetected epileptic condition. Consult your physician before operating the PlayStation®2 console if you have an epileptic condition or experience any of the following symptoms while watching TV programmes or playing video games: altered vision, muscle twitching, other involuntary movements, loss of awareness of your surroundings, mental confusion, and/or convulsions.

Software title compatibility

Some PlayStation® or PlayStation®2 format software titles may perform differently on this console than they do on previous PlayStation®2 or PlayStation® consoles, or may not perform properly on this console. For more information, visit our Web site at www.playstation.com

NOTICE FOR CUSTOMERS IN THE UNITED KINGDOM

A moulded plug complying with BS1363 is fitted to this equipment for your safety and convenience. Should the fuse in the plug supplied need to be replaced, a 5 AMP fuse approved by ASTA or BSI to BS1362, (i.e., marked with ⚡ or ⚡ mark) must be used. If the plug supplied with this equipment has a detachable fuse cover, be sure to attach the fuse cover after you change the fuse. Never use the plug without the fuse cover. If you should lose the fuse cover, please contact the appropriate PlayStation® customer service help line which can be found within every PlayStation® and PlayStation®2 format software manual.

The manufacturer of this product is Sony Computer Entertainment Inc., 2-6-21 Minami-Aoyama, Minato-ku Tokyo, 107-0062 Japan. The Authorised Representative for EMC and product safety is Sony Deutschland GmbH, Hedelfinger Strasse 61, 70327 Stuttgart, Germany. Distributed in Europe by Sony Computer Entertainment Europe Ltd, 10 Great Marlborough Street, London, W1F 7LP.

Precautions

Safety

This product has been designed with the highest concern for safety. However, any electrical device, if used improperly, has the potential for causing fire, electrical shock or personal injury. To help ensure accident-free operation, follow these guidelines:

- Observe all warnings, precautions and instructions.
- Stop use and unplug the AC power cord from the electrical outlet immediately if the device functions in an abnormal manner or produces unusual sounds or smells.
- Never connect cables other than those specified in this manual to the network connector.
- Contact the appropriate PlayStation® customer service helpline which can be found within every PlayStation® and PlayStation®2 format software manual if the device does not operate properly.

Use and handling

- When operating the unit, play in a well-lit room and keep a safe distance from the TV screen.
- Avoid prolonged use of the console. To help prevent eye strain, take a break of about 15 minutes during every hour of play.
- Stop using the console immediately if you experience any of the following symptoms. If the condition persists, consult a doctor.
 - Lightheadedness, nausea, or a sensation similar to motion sickness
 - Tired, uncomfortable or aching hands or arms
 - Tired, dry or aching eyes
- Do not use the console near water.
- Do not place the console and connected accessories on the floor or in a place where they may cause persons walking by to trip or stumble.
- Do not place the console or accessories on surfaces that are unstable, tilted or subject to vibration.
- Do not expose the console or accessories to high temperatures, high humidity or direct sunlight (use in an environment where temperatures range from 5°C to 35°C/ 41°F to 95°F).
- Do not place the console in locations of poor ventilation such as small, enclosed areas, directly against a wall or on a thick carpet or bedding.

- Do not expose the console to dust, smoke or steam.
- Do not allow liquid or small particles to get into the console.
- Do not put any objects on the console.
- Do not touch or insert foreign objects into the connectors of the console or accessories.
- Do not allow dust or foreign matter to build up around the console vents. Remove the dust with a low-powered vacuum cleaner.
- Set the console in a vertical or horizontal position only. When placing in the vertical position, use the vertical stand (for PlayStation®2) (SCPH-90110 E) (sold separately) that is compatible with this console. Also, do not change the position while the console is turned on.
- Do not leave a disc in the console when moving or changing the position of the console.
- Do not touch a disc while it is spinning.
- Do not close the disc cover in a way that could pinch your hand or fingers.
- Adjust the settings of the DVD player according to the instructions provided before playing a DVD.
- Keep the console and accessories, including cable ties and fasteners, out of the reach of small children.

AC power cord use

- Do not touch the plug of the AC power cord with wet hands.
- Do not touch the console or connected accessories during an electrical storm.
- Do not touch the console for extended periods of time while the console is turned on as extended contact may cause low-temperature burns.
- To help ensure safe operation, regularly inspect the AC power cord. If damaged, stop use immediately and contact the appropriate PlayStation® customer service helpline which can be found within every PlayStation® and PlayStation®2 format software manual.
- Do not use a power cord other than the supplied AC power cord.
- Check that there is no dust or lint on the mains power plug before inserting into an electrical outlet. If the plug becomes dirty, wipe it off with a dry cloth before connecting.
- Do not allow dust or foreign matter to build up around the connectors on the console. Before connecting or plugging in cords or cables, also check that there is no dust or foreign matter on the connectors of the cords or cables, or in or on the socket of the wall outlet. Dust or other matter on the connectors can result in fire

or electrical shock.

- Unplug the AC power cord from the electrical outlet before cleaning or moving the console, or when you do not intend to use the console for an extended period of time. When disconnecting, grasp the power cord by the plug and pull straight out of the electrical socket. Never pull by the cord and do not pull out at an angle.
- Do not connect the AC power cord to a voltage transformer or inverter.

When using software that supports the vibration function of the analog controller (DUALSHOCK®2)

Do not use the vibration function if you have any ailment or injury to the bones, joints or muscles of your hands or arms. In most cases, the vibration function can be set to "Off" in the options menu of the software.

Network (except Local Area Networks)

- A broadband Internet connection is required to connect to a network.
- When you connect your PlayStation®2 console to a network, the Internet service provider may charge additional usage fees. In some cases, usage charges may be more than anticipated. For details, refer to the information provided in your service contract or contact your Internet service provider.
- Parents are encouraged to monitor children in online gaming to ensure safe and responsible Internet usage.

Connecting with an Ethernet cable

Do not connect Ethernet cables or telephone cords of the following types to the network connector:

- Ethernet cables not appropriate for use with a 10Base-T/100Base-TX network
- Standard residential telephone lines
- Any ISDN (digital) compatible phone or data line
- PBX phone lines
- Other "unknown" types of telephone lines

Disc handling

- Do not touch the disc surface when handling a disc; hold it by the edges.
- Do not stick paper or tape onto discs and do not write on discs.
- Fingerprints, dust, dirt or scratches on the disc can distort the picture or reduce sound quality. Always handle carefully and make sure discs are clean before use.
- Do not leave discs near a heat source, in direct sunlight or in high humidity.

- Store discs in their cases when not in use.
- Clean discs using a soft cloth, lightly wiping from the centre outwards.
Do not use solvents such as benzene, commercially available cleaners not intended for CDs or anti-static spray intended for vinyl LPs.
- Do not use irregularly shaped discs (for example, heart- or star-shaped discs) or damaged, reshaped or repaired discs.

Never disassemble the console or supplied accessories

Use the PlayStation®2 console and accessories according to the instructions in the product documentation. No authorization for the analysis or modification of the console, or the analysis and use of its circuit configurations, is provided. There are no user serviceable components inside the PlayStation®2 console. Disassembling the console will void the warranty. Additionally, there is a risk of exposure to laser radiation as well as to electrical shock hazards.

When connecting the console to a plasma or projection* TV

Do not leave a still image on the TV screen for an extended period of time, as this may leave a faint image permanently on the screen.

* Except LCD screen types

Note on safety when playing DVDs or CDs

If you set the volume too high, it may harm your hearing or damage the speakers. Exercise care when setting the volume.

Moisture condensation

If the console or disc is brought directly from a cold location to a warm one, moisture may condense on the lens inside the console or on the disc. Should this occur, the console may not operate properly. In this case, remove the disc and turn off and unplug the console. Do not put the disc back in until the moisture evaporates (this may take several hours). If the console still does not operate properly, contact the appropriate PlayStation® customer service helpline which can be found within every PlayStation® and PlayStation®2 format software manual.

Cleaning

- For safety reasons, before cleaning the console or connected accessories, 1) turn off the console, 2) disconnect the mains power plug for the console from the electrical outlet, and 3) disconnect the Ethernet cable from the console.

- When cleaning the console, use a soft, dry cloth. Do not use solvents or other chemicals or a chemically-treated dust cloth to clean the product.
- Do not touch the lens located inside the disc cover. To help protect the lens from dust, keep the disc cover closed except when inserting or removing discs.

Exterior protection

To help prevent damage to the painted parts, follow the precautions below:

- Do not spill liquids such as alcohol, solvents or other chemicals on the product.
- Do not place any rubber or vinyl materials on the console exterior for an extended period of time.

NOTICE FOR THE CUSTOMERS IN THE UNITED KINGDOM



Where you see either symbol on any of our electrical products, batteries or packaging, it indicates that the relevant electrical product or battery should not be disposed of as general household waste in Europe. To ensure the correct waste treatment of the product and battery, please dispose of them in accordance with any applicable local laws or requirements for disposal of electrical equipment/batteries. In so doing, you will help to conserve natural resources and improve standards of environmental protection in treatment and disposal of electrical waste.

This product contains a battery which is permanently built-in for safety, performance or data integrity reasons. The battery should not need to be replaced during the lifetime of the product and should only be removed by skilled service personnel. To ensure the correct waste treatment of the battery, please dispose of this product as electrical waste.

Differences to previous PlayStation®2 models

This version of the PlayStation®2 console may be different from previous models in compatibility with optional accessories and the method of operating game software. For full details visit our Web site at www.playstation.com.

About the PlayStation®2 console documentation

The PlayStation®2 console documentation includes the following:

- **Quick Reference (this document)**

This document contains information on setting up and performing basic operations on the console, as well as safety and troubleshooting information.

- **User's Guide**

This document (in PDF format) is accessed from a PC through the Internet and contains information on performing advanced operations on the console, technical specifications and other information.

United Kingdom: uk.playstation.com/manuals

Australia: au.playstation.com/manuals

New Zealand: nz.playstation.com/manuals

For up-to-date information regarding the PlayStation®2 console, visit www.playstation.com.

Checking the package contents

Check that you have all of the following items. If any items are missing, contact the appropriate PlayStation® customer service helpline which can be found within every PlayStation® and PlayStation®2 format software manual.

- PlayStation®2 console ...1
- Analog controller (DUALSHOCK®2) ...1
- AV cable ...1
- AC power cord ...1
- Euro-AV connector plug (supplied with SCPH-90003) ...1
- Printed materials

1

Setting up the PlayStation®2 console

⚠ Warning

- Do not plug the AC power cord for the console into an electrical outlet until you have made all other connections.
- The socket-outlet shall be installed near the equipment and shall be easily accessible.

Before setting up

- Do not place the console in locations subject to excessive cigarette smoke or dust. Cigarette smoke residue or dust build-up on the internal components, such as the lens, may cause the console to malfunction.
- Make sure the TV is turned off before connecting the PlayStation®2 console.

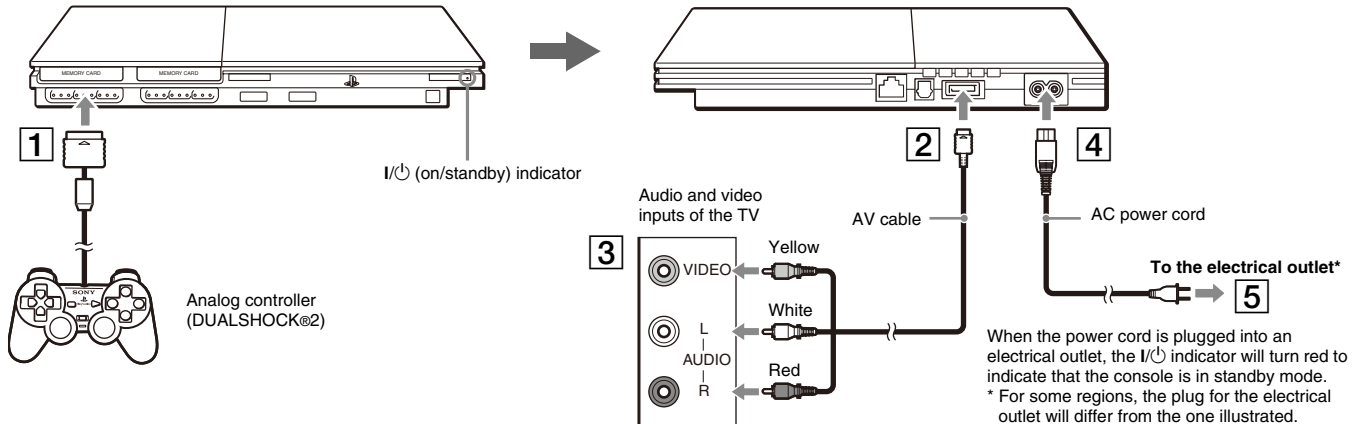

When using a cable other than the supplied AV cable, see "When using a cable other than the supplied AV cable" (→ page 14).

Hint

You can connect various USB devices to the PlayStation®2 console, but not all are compatible. Refer to the instructions supplied with the USB device for more information.

When using the Euro-AV connector plug (SCPH-90003)

Connect your PlayStation®2 console to the Euro-AV connector (SCART) on the TV using the Euro-AV connector plug and AV cable, making sure you match the colour-coded plugs of the AV cable to the matching jacks of the connector plug.

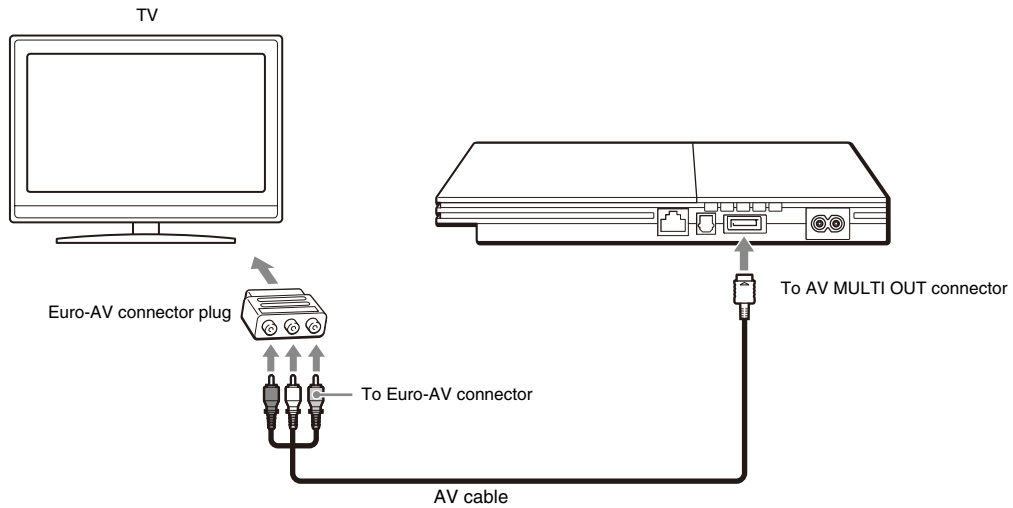

2

Turning the console on and off

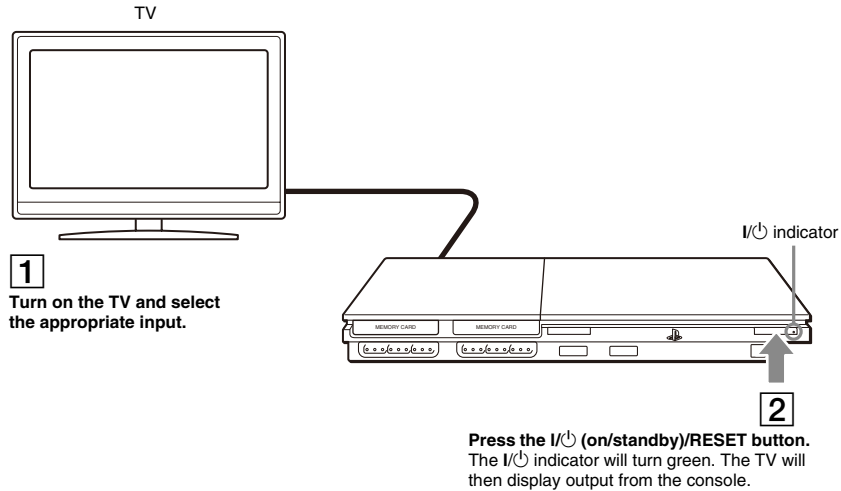

Turning off the console

Press and hold the I/O/RESET button for at least one second. The I/O indicator will turn red to indicate that the console is in standby mode.

Hint

In standby mode, power to the console is not completely turned off. If you will not be using the console for an extended period of time, unplug the power cord from the outlet.

3

Playing content

You can play games, DVD-Videos and audio CDs on the PlayStation®2 console. Insert the disc to start playback.

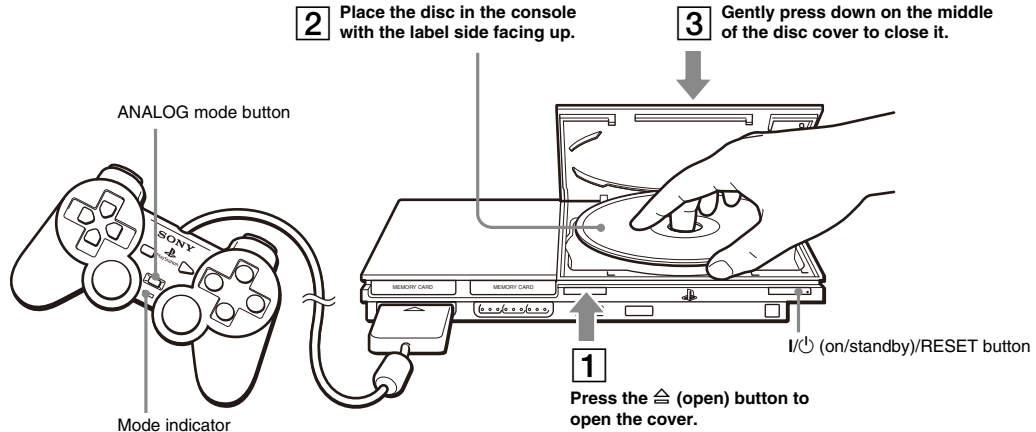

For instructions on playing a game, see "Playing a game" (→ page 11).

For DVDs, see "Watching a DVD" (→ page 12).

For audio CDs, refer to the User's Guide (→ page 6).

Outputting Dolby Digital or DTS audio

Connect a digital audio device to the PlayStation®2 console using a commercially available optical digital cable (for audio).

- To output audio from DVD-Videos: From the control panel (→ page 12), set "Dolby Digital" or "DTS" to "On" under  (Setup) → "Audio Setup" → "Audio Digital Out".
- To output audio from games: The setup method varies depending on the game. For details, refer to the instructions supplied with the game.

Playing a game

You can play PlayStation®2 and PlayStation® format software on the PlayStation®2 console.

Starting a game

Insert the disc to start playback.

Resetting a game

Press the I/O/RESET button. Be careful not to accidentally press the I/O/RESET button while playing a game, as doing so will cause the game to reset.

Ending a game

After saving game data, turn the console off, and then remove the disc.

Using the analog controller (DUALSHOCK®2)

The analog controller (DUALSHOCK®2) is equipped with pressure-sensitive buttons and sticks. This enables you to control game action with enhanced precision based on the force with which buttons are pressed or the angle at which the analog stick is tilted. It is also a force feedback controller with a vibration function.

Switching modes

Depending on the game, you may need to set the controller to either digital or analog mode. Press the ANALOG mode button of the controller to switch to the analog mode (indicator: red). To return to digital mode, press the ANALOG mode button again. Some games make this adjustment automatically.

Using memory cards

You can save and load game data using a memory card (sold separately). You can also delete game data or copy game data from one memory card to another.

Memory card types

There are two types of memory cards. Select a memory card suitable for the software in use.

Memory card type	Compatible software	Amount of memory
Memory card (8MB) (for PlayStation®2) (SCPH-10020 E)	PlayStation®2 format software	Approx. 8 MB
Memory card (SCPH-1020 E)* * This product is no longer manufactured.	PlayStation® format software	15 memory blocks (approx. 120 KB)

MagicGate™ is a term of copyright-protection technology developed by Sony Corporation.

Inserting a memory card

Insert the memory card into a memory card slot. Some games designate a specific memory card slot to use.

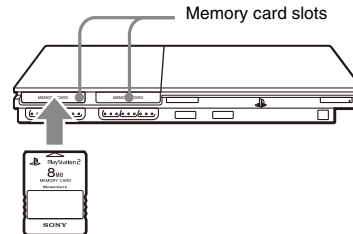

Copying or deleting saved data

You can delete saved data or copy data to another memory card. Use directional buttons and the  button to select items.

- 1 With no disc inserted in the console, turn on the console, and then insert a memory card.**
- 2 Select "Browser", and then select the memory card you want to copy or delete data from.**
- 3 Select the icon for the data item, and then select "Copy" or "Delete".**

Follow the on-screen instructions to complete the operation.

Playing online games

You can play online games by connecting the PlayStation®2 console to a network.

Items you will need

- A network compatible PlayStation®2 game
- Broadband Internet service
- A commercially available Ethernet cable
- A memory card (8MB) (for PlayStation®2) (sold separately)

Creating a network configuration

When playing online games, insert a commercially available Ethernet cable into the network connector, and then create a network configuration. Refer to the instructions supplied with the online game for creating a network configuration.

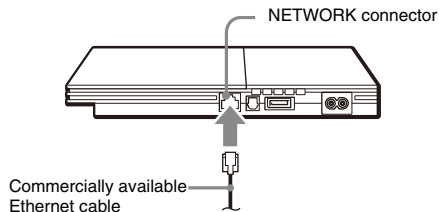

Watching a DVD

You can play DVDs on the PlayStation®2 console.

Starting a DVD

Insert the disc to start DVD playback.

Operating the DVD player

Press the **SELECT** button.

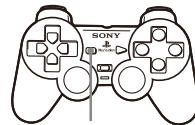

SELECT
button







The control panel
is displayed on
the screen.

Select an icon.



Control panel items

You can select the following options in the control panel.

Icon		Function
	Menu	Displays the DVD-Video menu
	Top Menu	Displays the DVD-Video menu
	Return	Returns to the previously selected screen within the DVD's menu
	Audio Options	Displays and changes audio options on DVDs with multiple audio tracks
	Angle Options	Displays and changes viewing angles on DVDs recorded with multi-angle options

Icon		Function
	Subtitle Options	Displays and changes subtitle options on DVDs with subtitle options
	Go To	Skips to the selected title, chapter or the specified time, and starts playback
	Setup	Displays and changes options for language, picture quality, Parental Control level, audio, etc.
	Time Display	Displays the current title or chapter number, the elapsed time, etc.
	Help	Displays the direct button functions of the analog controller (DUALSHOCK®2)
0~9	Go to Chapter	Used to enter the number of a chapter you want to play
	Previous/Next	Returns/skips to the beginning of the current, previous or next chapter
	Search	Fast reverses/forwards playback
	Slow	Changes to playback/reverse playback in slow-motion
	Play	Starts playback
	Pause	Pauses playback
	Stop	Stops playback. Selecting (Stop) again after playback is stopped clears resume play (playback from the last stopping point).
A-B	A-B Repeat	Specifies a scene for playback, and starts playback of the scene that has been set
	Shuffle Play	Begins playback of titles or chapters in a random order
	Program Play	Begins playback of titles or chapters in a programmed sequence
	Repeat Play	Selects repeated playback of all the titles on the disc, or one title or one chapter

Icon		Function
	Original/Play List	For DVD-RW discs (VR mode), selects Original or Play List content to play
	Clear	Clears selected numbers or playback modes

Hints

- For more details on control panel items, refer to the User's Guide (➡ page 6).
- The DVD player can be operated using the DVD remote control (for PlayStation®2) (sold separately).
- Some control panel options cannot be selected during resume play. To select these options, cancel resume play by selecting (Stop) on the control panel and then selecting (Stop) again after playback is stopped.

Parental control settings

Setting parental control restrictions

From the control panel, select  (Setup) → "Custom Setup" → "Parental Control".

Follow the on-screen instructions to register or enter the password. After the password is registered or entered, proceed through the various screens to select a region and parental control level.

Hints

- If you select "Other" in the region options, refer to the User's Guide (➡ page 6) for a list of region codes.
- For the parental control level, note that the lower the value, the stricter the restriction.
- To clear the parental control setting, set the option to "Off".
- To change your password, select "Change Password" from the parental control options and follow the on-screen instructions to complete the operation.

Temporary override of parental control restrictions

Start DVD playback. When prompted by the system, select "Yes", and then enter the password.

Hints

- You cannot change the parental control setting without a password.
- When DVD playback is stopped, the parental control level will return to its default setting.
- If you forget your password, see "Troubleshooting" (➡ page 17).

When using a cable other than the supplied AV cable

Picture quality varies depending on the type of cable used. Use the information below to determine the best connection method. If you use a cable other than the supplied AV cable, refer to the instructions supplied with the cable.

TV	Cable type
A TV with component video input connectors	Component AV cable (SCPH-10490)
A TV with Euro-AV (SCART) connector	Euro-AV Cable (SCPH-10142) (for SCPH-90003)
A TV with S VIDEO inputs	S VIDEO cable (SCPH-10480)

Picture quality scale

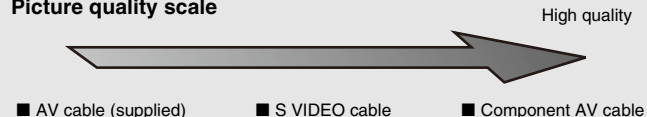

This scale is intended only as a reference. Depending on the product or condition of your TV, the picture quality may be different. When using the Euro-AV Cable, picture quality may vary depending on your TV's AV connection. For optimum picture quality, connect your Euro-AV cable to an RGB-compatible socket on your TV. Refer to the instructions supplied with your TV for details.

Compatible software





DVD	PlayStation®2 format DVD-ROM
	DVD-ROM (DVD-Video)
	DVD+R / DVD+RW
	DVD-R / DVD-RW (Video mode / VR mode)
CD	PlayStation®2 format CD-ROM
	PlayStation® format CD-ROM
	CD-DA (Audio CD)

Notes

- Some discs may not be playable due to scratches, dust or recording problems.
- Throughout this manual, the term "DVD-Video" is used to refer to DVD-R, DVD-RW (Video mode), DVD+R and DVD+RW discs.
- The audio CD playback feature of this product is designed to conform to the Compact Disc (CD) standard. Recently, some record companies have started marketing music discs encoded with copyright protection technologies. Some of these music discs do not conform to the CD standard and may not be playable on this product.
- A DualDisc is a two sided disc product that contains DVD recorded material on one side and digital audio material on the other side. However, since the audio material side does not conform to the Compact Disc (CD) standard, playback on this product is not guaranteed.
- Do not play illegally copied discs. This may cause a malfunction or damage to the console.

Region codes

Some discs are assigned "region codes" for each geographic sales region. This console can play discs with the following region codes.

Disc	Region code
DVD	 (SCPH-90002 only)
	 (SCPH-90003 only)
	
PlayStation®2 format DVD-ROM PlayStation®2 format CD-ROM PlayStation® format CD-ROM	

DVD-Videos

This console can only play discs recorded for the PAL broadcast standard.

DVD-R, DVD-RW, DVD+R and DVD+RW discs

- Only discs that have been finalized can be played.
- Copy-protected video from a digital broadcast recorded on Content Protection for Recordable Media (CPRM) compatible DVD-RW discs or on CPRM compatible DVD-R discs cannot be played on this console.

Accessories

When purchasing optional accessories, be sure to purchase those that are compatible with this model of the PlayStation®2 console.

About the DVD remote control (for PlayStation®2)

When purchasing a new DVD remote control, choose model number SCPH-10420 E which does not include the IR receiver unit (for PlayStation®2).

About multitaps

Only the multitap (for PlayStation®2) (SCPH-70120 E) (sold separately) can be used with this console. Do not connect multitap products with other model numbers to the console as this may result in damage to the console.

Accessories not compatible with this model

The following accessories for the PlayStation® console and the PlayStation®2 console are not compatible with this model of the PlayStation®2 console.

Model number	Product name
SCPH-10350 E	Network Adaptor (Ethernet) (for PlayStation®2)
SCPH-10090 E	Multitap (for PlayStation®2)
SCPH-1070 E	Multitap
SCPH-10040 E	Vertical stand (for PlayStation®2)
SCPH-70110 E	Vertical stand (for PlayStation®2)
SCPH-10110 E	Horizontal stand (for PlayStation®2)
-	Products that use the  S400 i.LINK connector

Troubleshooting

Go through this section if you experience difficulty in operating the PlayStation®2 console. Should any problem persist, call the PlayStation® service line at the number listed on your guarantee card for assistance.

Check the following items first:

- Check that the console is turned on. Press the I/⏻ RESET button to turn on the console (the I/⏻ indicator will turn green).
- Check that the AC power cord is fully inserted into the electrical outlet.
- Check that the cables are correctly and securely connected.

Picture

There is no picture on the TV screen.

- ➔ Switch the input mode of the TV as appropriate for the input connector in use on the console.
- ➔ There may be a problem with the cable. Try using another cable that is compatible with the PlayStation®2 console.

The picture is unstable.

- ➔ Set "Component Video Out" to "Y Cb/Pb Cr/Pr" in the System Configuration menu when connecting the console to the component AV inputs on a TV*. Use the supplied AV cable to make the setting, and then connect to the TV using the component AV cable (sold separately).
* When connecting the console to a TV that only supports RGB input, set "Component Video Out" to "RGB".
- ➔ When the console is connected to a VCR or a DVD recorder, copy protection used by some DVDs may cause the picture to become unstable, or the picture may get brighter or darker. If this happens, connect the console directly to the TV.
- ➔ If the console is connected to a TV or cable*1 that does not support progressive scan (480p), no video will be displayed when "Progressive" is set to "On" under  (Setup) → "Screen Setup" in the DVD player's control panel. In this case,

with a DVD inserted, press the I/⏻/RESET button and immediately press and hold down the START button of the controller*2. The "Progressive" setting will be cleared and video from the DVD will be displayed properly.

*1 The component AV cable (sold separately) is compatible with progressive scan.

*2 Connect the controller to controller port 1.

The size of the video image and the TV screen do not match.

- ➔ If the console is connected to a widescreen TV (16:9), check the settings on the TV as they may override those for the console. Refer to the instructions supplied with your TV for details.
- ➔ Adjust the image size of the DVD to match your TV screen. Start a DVD, and then stop playback. Adjust the "TV Type" setting under  (Setup) → "Screen Setup" in the control panel.
- ➔ With some DVDs, image size cannot be changed.
- ➔ Check that the console is directly connected to the video input connector of the TV. If there is a selector or receiver (AV amplifier) connected between the console and the TV, the image size cannot be changed.
- ➔ With some TVs, image size cannot be changed.

Sound

There is no sound.

- ➔ Check that the TV volume is not set to "mute" and adjust the TV volume to an appropriate level.
- ➔ If the console is connected to an audio device, check the settings on the connected device. Refer to the instructions supplied with the device for details.
- ➔ There may be a problem with the cable in use. Try using another cable that is compatible with the PlayStation®2 console.
- ➔ Some PlayStation®2 format software titles do not support audio output from the DIGITAL OUT (OPTICAL) connector. When playing such software, no sound will be produced even if you connect using an optical digital cable for audio. Connect the console to the audio device using an analog AV cable, such as the supplied AV cable.

There is no sound or the sound quality from the digital audio device is poor.

- ➔ If the console is connected to a digital audio device you must adjust the "Digital Out (Optical)" setting. Turn on the console with no disc inserted, and in the System Configuration menu set "Digital Out (Optical)" to "On".
- ➔ When playing DTS audio, set "DTS" to "On" in  (Setup) → "Audio Setup" → "Audio Digital Out". If the connected device does not have a built-in DTS decoder, DTS audio cannot be played.

The surround effect is not produced when playing a DVD with a Dolby Digital audio track.

- ➔ Check that the console is connected to an audio device with a built-in Dolby Digital decoder using an optical digital cable.
- ➔ To play Dolby Digital audio, set "Dolby Digital" to "On" in  (Setup) → "Audio Setup" → "Audio Digital Out" in the DVD player control panel.

Operation

A disc cannot be played.

- ➔ Check that the disc is of a type that can be played on the console.
- ➔ Check that the disc is clean and in good condition. If the disc is dirty, wipe it gently with a soft cloth.
- ➔ Some PlayStation® format software may not perform properly on this console. For more information, visit our Web site at www.playstation.com.
- ➔ If the disc has a label, place the disc in the console with the label side facing up.
- ➔ If a DVD-R or DVD-RW disc is not finalized, it cannot be played.
- ➔ Copy-protected video from a digital broadcast recorded on Content Protection for Recordable Media (CPRM) compatible DVD-RW discs or on CPRM compatible DVD-R discs cannot be played on this console.
- ➔ Check that the region code of the DVD is correct for the console in use. Also check that the broadcast standard is correct.
- ➔ The parental control feature may be set on the disc. Follow the on-screen instructions and temporarily raise the parental control restriction level.

The controller does not function correctly.

- ➔ If a software title is compatible only with the analog controller (DUALSHOCK®2), it will not work properly with the analog controller (DUALSHOCK®). Use a controller that is appropriate for the software title. Refer to the instructions supplied with the software for details.
- ➔ Some software specifies a specific controller port that must be used. Check that the controller is connected to the correct port. Refer to the instructions supplied with the software for details.
- ➔ There may be a problem with the controller in use. Try using another controller that is compatible with the PlayStation®2 console.

The response to button operations is slow.

- ➔ The response speed of some LCD TVs and PC displays is slow. This is not a malfunction.

The left and right analog sticks of the controller do not operate properly.

- ➔ When these symptoms occur, rotate the left and right analog sticks of the analog controller (DUALSHOCK®2) in a large circle to adjust the sticks to an optimal range of operation. Be sure to rotate in a circle, not twist the sticks.

The console does not recognize the memory card. Data cannot be saved or copied to the memory card.

- ➔ Check that the memory card is compatible with the software in use. To save or load PlayStation®2 format software, use a memory card (8MB) (for PlayStation®2) (SCPH-10020 E). To save or load PlayStation® format software, use a memory card (SCPH-1020 E).
- ➔ You cannot copy saved data from PlayStation®2 format software to a memory card (SCPH-1020 E).
- ➔ Check that the memory card is securely inserted into the console.
- ➔ There may be a problem with the memory card in use. If you have another memory card that is compatible with the PlayStation®2 console, try switching memory cards.

Data saved on a memory card is corrupted.

- ➔ While saving, loading, copying or deleting data, do not attempt any of the following. Doing so may cause the data to become corrupted.
- Do not remove the memory card or the controller.
 - Do not open the disc cover.
 - Do not reset the console.
 - Do not turn off the console.

The console does not function properly.

- ➔ Static electricity and other similar occurrences may affect the console's operation. Turn off the console and unplug it from the electrical outlet. Then plug in the console and turn it on.

The I/O indicator flashes in red and the console does not work.

- ➔ Do not use the console until the flashing stops. Placing the console in an extremely hot location or blocking the console's vents raises the internal temperature of the console, thereby preventing proper operation.

You forgot your password.

- ➔ You can clear the password using the following procedure:
- 1 Insert a DVD without the parental control feature.**
 - 2 In the control panel, select ■ (Stop) to stop playback, and then select ■ (Stop) again to clear resume play.**
 - 3 In the control panel, select  (Setup) → "Custom Setup" → "Parental Control" and then press the (X) button.**
The screen to enter a password is displayed.
 - 4 Press the SELECT button on the controller, and then enter the number "7444" on the screen that is displayed.**
The registered password is cleared, and the screen for registering a new password is displayed. Enter a new password.

The DVD does not function. Some DVD settings cannot be changed.

- ➔ The playback status or settings of some DVDs are preset intentionally by the manufacturer. Because the PlayStation®2 console plays DVDs according to the

settings on the disc, some functions may not be available even if you follow the procedures in this document and the User's Guide (➔ page 6).

- ➔ Some settings cannot be changed during playback or resume play. Select ■ (Stop) in the control panel to stop playback, and then select ■ (Stop) again to clear resume play.

Network

A connection to the network cannot be established.

- ➔ Check that the network settings are correct. Refer to the information from your broadband Internet service provider and the instructions supplied with the software in use and adjust the settings accordingly.
- ➔ Check that the Ethernet cable is properly connected.
- ➔ Check that you are using the correct type of Ethernet cable (cross cable or straight cable). Refer to the instructions supplied with the network device for details.
- ➔ Check that the network device is properly connected. Also check that the settings of the network device in use are correct. Refer to the instructions supplied with the network device for details.

Guarantee

Thank you for buying this Product. The term "Product" means the PlayStation®2 computer entertainment system together with the accessories and/or peripherals with which it is packaged. This Guarantee does not cover any software whether or not packaged with the Product.

Sony Computer Entertainment Europe Ltd ("SCEE") guarantees that this Product is free from defects in material and workmanship that result in Product failure during normal usage in accordance with the terms set out in below and will, for a period of 1 (one) year from the date of original purchase, repair or (at SCEE's option) replace any component part of this Product, free of charge, where it is faulty due to defective materials or workmanship. Replacement will be with a new or refurbished component or unit, at SCEE's option, which is guaranteed for the remainder of the original Guarantee Period.

The benefits conferred by this Guarantee are in addition to the statutory rights and remedies the consumer has in the UK and Eire in respect of this Product and this Guarantee does not affect such rights and remedies in any way. The benefits conferred by this Guarantee are also in addition to other rights and remedies which the consumer has in law in Australia and New Zealand in respect of this Product, including rights and remedies available under the Trade Practices Act 1974 and State and Territory legislation in Australia and the Fair Trading Act 1986 in New Zealand and this Guarantee does not affect such rights and remedies in any way.

This Guarantee is given to you by Sony Computer Entertainment Europe Ltd of 10 Great Marlborough Street, London, W1F 7LP, United Kingdom.



IMPORTANT

1. If you need to claim under this Guarantee, please call your local Customer Service helpline (listed in a PlayStation® and PlayStation®2 format software manuals) for return instructions and other guidance.
2. This Guarantee is only valid:
 - i. in the United Kingdom, Eire, Australia and New Zealand; and

- ii. when the original sales receipt or invoice or other proof of purchase (indicating the date of purchase and retailer's name) is presented together with the faulty Product (and has not been altered or defaced since the date of original purchase); and
 - iii. when the Guarantee seal and the serial number on the Product have not been damaged, altered or removed.
3. You may not claim under this Guarantee when the Product is damaged as a result of:
 - i. commercial use, accident, fair wear and tear, negligence, abuse, or misuse (including, without limitation, failure to use this Product for its normal purpose and/or in accordance with instructions on proper use and maintenance, or installation or use in a manner inconsistent with applicable local technical or safety standards);
 - ii. use in conjunction with any unauthorised peripheral (including, without limitation, game enhancement devices, adaptors and power supply devices);
 - iii. any adaptation or adjustment to, or alteration of, the Product carried out for any reason, and whether properly carried out or not;
 - iv. maintenance or repairs carried out other than by a SCEE authorised service facility; or
 - v. use in conjunction with unauthorised software, virus infection, or fire, flood or other natural calamity.
4. To the extent permitted by applicable law, this Guarantee will be your sole and exclusive remedy in relation to defects in this Product and all other guarantees, warranties, terms and conditions, express or implied by statute or otherwise, in respect of this Product are excluded and neither SCEE nor any other Sony entity, or their suppliers or authorised service facilities, will be liable for any special, incidental, indirect or consequential loss or damage.

If this Product needs any repair which is not covered by this Guarantee, please call your local Customer Service helpline for advice. If your home country is not one of those listed, please contact your retailer.

Copyrights and trademarks

"", "PlayStation", "", "DUALSHOCK" and "" are registered trademarks of Sony Computer Entertainment Inc.

"SONY" and "" are registered trademarks and "MagicGate" is a trademark of Sony Corporation.

This product incorporates copyright protection technology that is protected by method claims of certain U.S. patents and other intellectual property rights owned by Macrovision Corporation and other rights owners. Use of this copyright protection technology must be authorized by Macrovision Corporation, and is intended for home and other limited viewing uses only unless otherwise authorized by Macrovision Corporation. Reverse engineering or disassembly is prohibited.

This product is manufactured under license from Dolby Laboratories. "Dolby" and the double-D symbol are trademarks of Dolby Laboratories.

Confidential unpublished works. ©1992-1997 Dolby Laboratories. All rights reserved.

"DTS" and "DTS Digital Out" are trademarks of DTS, Inc.

i.LINK and i.LINK logo "" are trademarks.

Sony Computer Entertainment Inc. uses DNAS (Dynamic Network Authentication System), a proprietary authentication system, to help protect copyright and security in connecting the PlayStation®2 console to a network. DNAS may retrieve information about a user's hardware and software for authentication, copy protection, account blocking, system, rules, or game management and other purposes. The information collected does not identify the user personally. The unauthorised transfer, exhibition, export, import or transmission of programs and devices circumventing its authentication scheme may be prohibited by law.

About copy protection

Attempted copying of DVDs played on this device may be prevented or restricted by copy protection technology contained on the DVD. Attempted recording or copying of DVDs for private use by the removal or circumvention of copy protection technology may be prohibited under applicable law.



3 - 2 8 9 - 7 9 9 - 5 2

SONY



COMPUTER
ENTERTAINMENT®

www.playstation.com

COMPACT
disc

DOLBY
DIGITAL

dts
DIGITAL OUT

DVD
ROM™

DVD
VIDEO™